

6-GFM-200Ah

Valve-regulated Lead Acid Battery Specification

Features

- Maintenance free
- Safety and no leakage
- Excellent recharge and discharge performance
- Low self-discharge rate
- Adapt to high or low temperature
- Good deep discharge performance
- Longer cycle life



Specification

Rated Voltage	12V
Numbers of cells	6 Cells
Capacity	200Ah@10hr-rate to 1.80V per cell @25°C
Weight	57.9kg
Internal Resistance	Approx. 3 mΩ
Terminal	F8
Max. Discharge Current	3000A(5s)
Short Circuit Current	10000A
Max. Charging Current	50A
Reference Capacity	C10 200.0AH C3 153.3AH C1 110.4AH
Design Life	10~15 years
Float Charging Voltage	13.6 V~13.8 V @ 25°C Temperature Compensation: -20mV/°C/Cell
Cycle Use Voltage	14.4 V~14.9 V @ 25°C Temperature Compensation: -30mV/°C/Cell
Operating Temperature Range	Discharge: -15°C~50°C Charge: 0°C~40°C Storage: -15°C~40°C
Normal Operating Temperature Range	25°C±5°C
Self Discharge	Less than 3% at 25°C per month
Container Material	A.B.S. UL94-HB, UL94-V0 Optional.

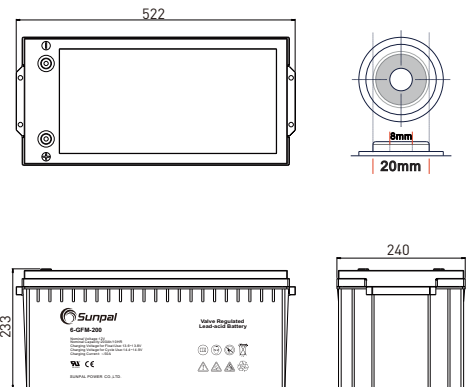

Length	522±2mm (20.6 inches)
Width	240±1mm (9.4 inches)
Height	219±1mm (8.6 inches)
Total Height	223±1mm (8.8 inches)

Constant Current Discharge Characteristics: A(25°C)

F.V/Time	5min	10min	15min	20min	30min	45min	1h	3h	5h	10h	20h
1.80V/cell	459.6	343.8	276.4	226.2	179.6	134.0	105.6	51.1	33.6	20.0	10.4
1.75V/cell	518.0	377.8	302.0	243.3	186.4	138.9	110.4	52.0	34.4	20.2	10.5
1.70V/cell	570.4	411.8	322.4	255.8	194.0	144.4	114.0	53.6	35.3	20.4	10.7
1.65V/cell	629.1	444.4	342.9	271.8	204.7	148.2	117.8	55.8	36.2	20.8	10.8
1.60V/cell	693.8	482.4	366.7	289.6	216.0	154.4	122.0	57.6	37.6	21.0	10.9

Constant Power Discharge Characteristics: WPC(25°C)

F.V/Time	5min	10min	15min	20min	30min	45min	1h	3h	5h	10h	20h
1.80V/cell	831.1	627.8	509.1	420.2	336.9	255.3	202.7	99.1	65.6	39.6	20.6
1.75V/cell	917.1	678.7	549.1	447.8	346.9	262.4	211.1	100.4	67.1	39.8	20.7
1.70V/cell	982.0	722.9	578.2	467.1	359.1	272.0	216.9	103.1	68.7	40.2	21.1
1.65V/cell	1067.6	773.1	610.0	492.4	375.8	276.2	222.7	106.9	70.2	40.9	21.4
1.60V/cell	1150.2	820.2	641.6	518.9	393.8	286.4	229.3	109.8	72.2	41.3	21.5

6-FM-200Ah

Valve-regulated Lead Acid Battery Specification

Charge Characteristics for Float Use @ 25°C/77°F

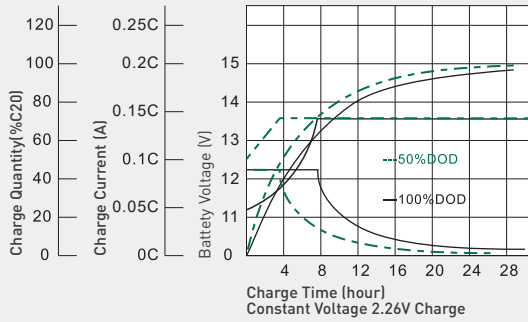

Discharge Characteristics at Various Rates @ 25°C/77°F

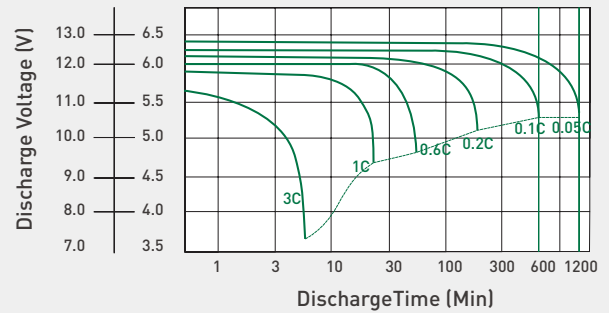

Cycle Life in Relation to Depth of Discharge

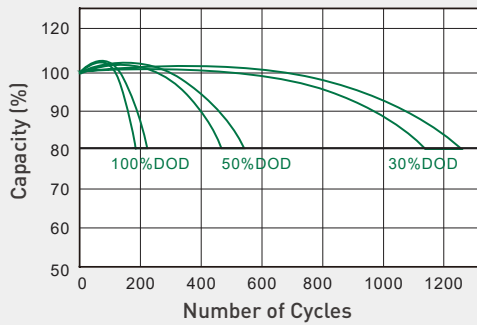

Float Service Life

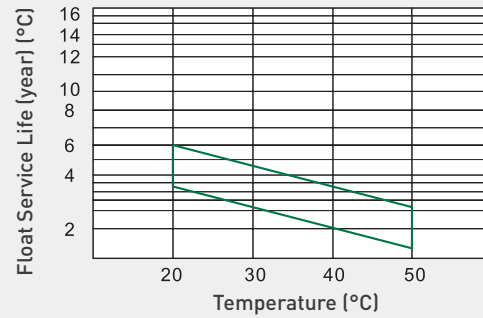

Temperature and Valid Capacity

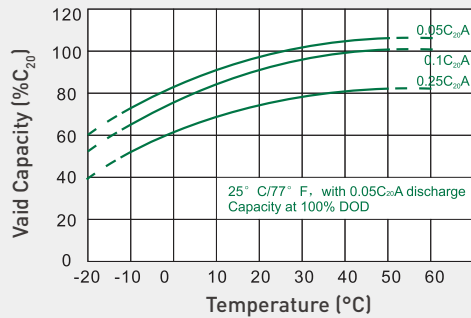

Self Discharge Characteristics

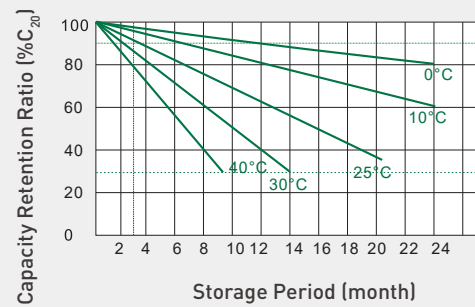

Capacity and Open Circuit Voltage

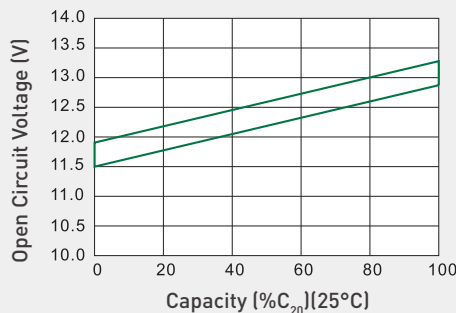

Relationship between Charging Voltage and Temperature

